

AGS1162

double-bowl sink with drainer | INSET or UNDERMOUNT







OUR REVOLUTIONARY TECHNOLOGY

Our manufacturing system uses a moulding technology system, meaning Artusi GraniteK sinks consist of a substantial and even distribution of its components including within the sink mass. This technology is internationally patented. GraniteK is the name given to our process of bonding granite and acrylic resin. This process results in the highest-quality finish, as it gives greater protection against high temperatures, cracks and chips, and is more resistant to violent impacts.

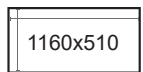
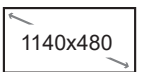

AGS1162 double-bowl sink with drainer BLACK or WHITE GRANITEK

Features

 1160x510 Dimensions (mm)	 1140x480 Built-in hole (mm)	 800 Base	 Inset
 Anti-bacterial surface	 Reversible	 Rectangular overflow	 200 Bowl depth (mm)

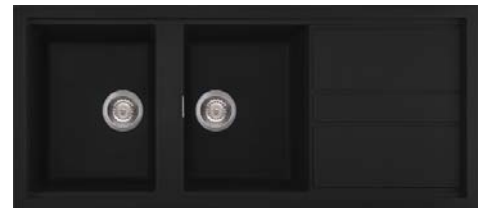

AGS1162B



AGS1162W

Sink Kit:
Space saving siphon, waste and pre-mounted hooks, rectangular overflow

Available accessories:
ARI01300 - Drain Rack
ATL11600 - Wooden Chopping Block



CERAMISATION COMPARISON:
This is a specific method in colouring the granite-particles. Their colouring of the materials happens not only on the surface, but also in all the particles' mass, through a particular firing process heating the material to over 700°C. This ensures the colour can penetrate deeply, reaching particles' core. The result give the end product the highest resistance against discolouring.

EAN AGS1162B: 9347777001467

EAN AGS1162W: 9347777001474

DISCLAIMER

Eurolinx PTY LTD is continually seeking ways to improve the design specifications, aesthetics and production techniques of its products. As a result alterations to our products and designs take place continually. Whilst every effort is made to produce information and literature that is up to date, this brochure should not be regarded as an infallible guide to the current specifications, nor does it constitute an offer for the sale of any particular product. Product dimensions indicated in our literature is indicative only. Actual product only should be used to define dimension cutouts. Distributors, and retailers are not agents of Eurolinx and are not authorized to bind Eurolinx by any express or implied undertaking or representation.

AGS1162

double-bowl sink with drainer | INSET or UNDERMOUNT

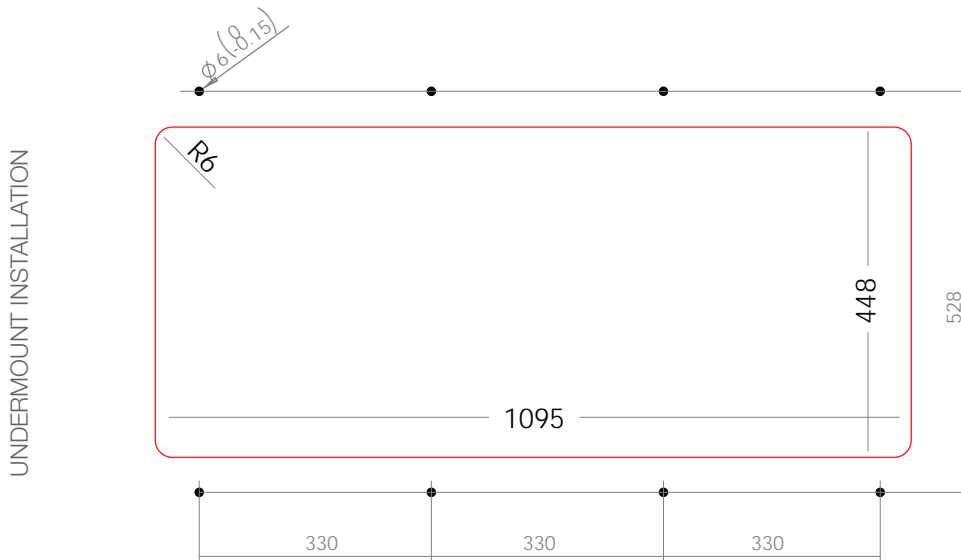
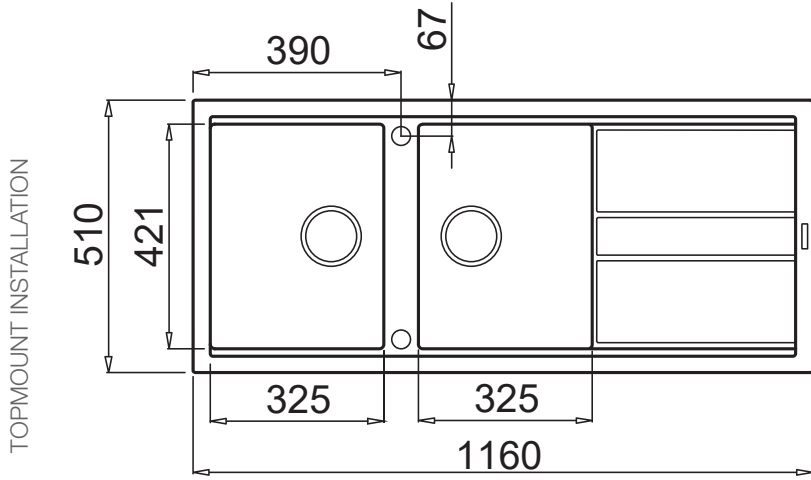

NB: drawings are not to scale — they are to be used as a guide only. For detailed installation instructions, please refer to user guide.

Australia National Telephone Number 1300 694 583 New Zealand Telephone Number 0508 458 369
 ARTUSI showrooms are open Tuesday to Friday from 9am-5pm and Saturdays 10am-4pm

artusi.com.au

NSW & ACT
(head office)

48 Moore Street
 Leichhardt
 02 8569 4699

VIC | SA

1211 Toorak Road
 CAMBERWELL
 03 9809 2155

TASMANIA

3 Pear Avenue
 DERWENT PARK 7009
 03 6272 7386

QLD

1/42 Cavendish Road
 COORPAROO
 07 3397 0850

WA | NT

10/55 Howe Street
 OSBORNE PARK
 08 9201 9188

New Zealand

PO Box 11.160
 Sockburn Christchurch
 03 344 5906